



# Drypower

12.8V	32.4Ah	LiFePO <sub>4</sub>	415Wh
-------	--------	---------------------	-------

## 12LFP32

Rechargeable Lithium Iron Phosphate Battery



### SPECIFICATIONS

<b>Nominal Voltage</b>	12.8V
<b>Nominal Capacity @5hr Rate</b>	32.4Ah
<b>Watt-hour</b>	414.72Wh
<b>Dimensions</b>	
Length	175 ± 3mm
Width	175 ± 3mm
Height	110 ± 3mm
Overall Height	113 ± 3mm
<b>Weight</b>	3.6kg
<b>Internal Resistance (at 1KHz)</b>	≤60mΩ
<b>Charge @25°C</b>	
Standard Charge Current	6A
Maximum Charge Current	30A
Max Charge Voltage	14.6V
<b>Discharge @25°C</b>	
Standard Discharge Current	6A
Max. Continuous Discharge	30A
Cut-off Voltage	10V
<b>Cell Used</b>	IFR26650-36A
<b>Assembly</b>	4S9P-Cyl
<b>Cycle Life (±0.5C, 25°C)</b>	
100% DoD	≥2000 cycles
80% DoD	≥4000 cycles
50% DoD	≥5000 cycles
<b>Operating Temperature</b>	
Charge	0°C ~ +45°C
Discharge	-20°C ~ +60°C
Storage	-20°C ~ +45°C
<b>Operating Humidity Range</b>	5% – 85%
<b>Case Material</b>	ABS
<b>Termination</b>	F18 (M8 Bolt) + lead to Anderson Plug
<b>Ingress Protection Rating</b>	IP54
<b>Series Connection</b>	Stand alone use only
<b>Parallel Connection</b>	No
<b>Barcode</b>	 9319632530412

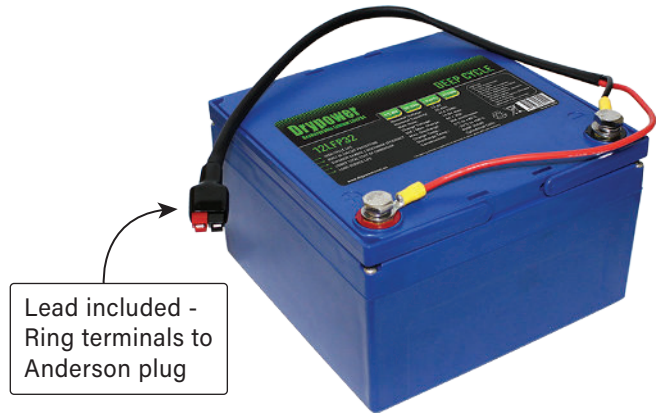

Lead included - Ring terminals to Anderson plug

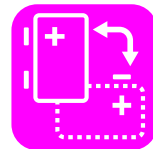

**Any orientation** - Drypower Rechargeable Lithium batteries with cylindrical LiFePO<sub>4</sub> cells inside can be used and mounted in any orientation, offering ultimate flexibility in a wide variety of applications.

### DIMENSIONS

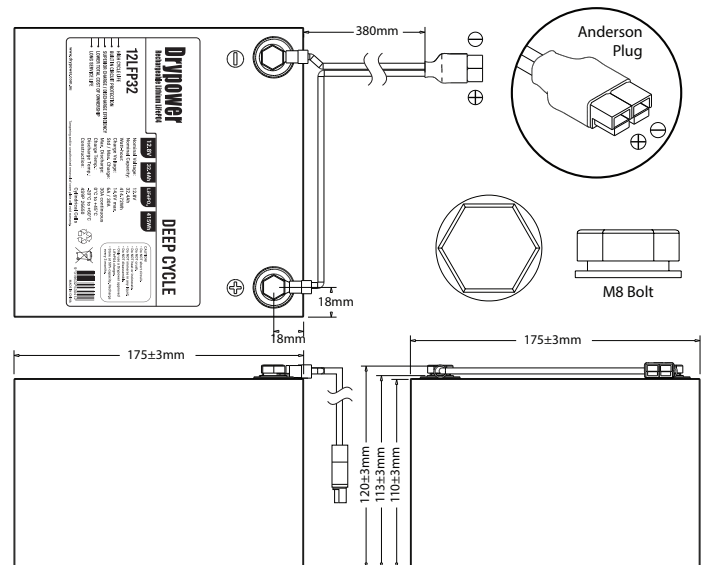

### CHARACTERISTICS CHARTS

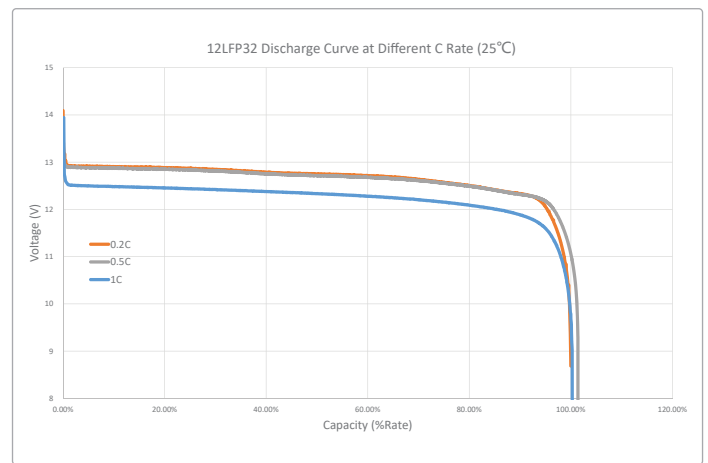
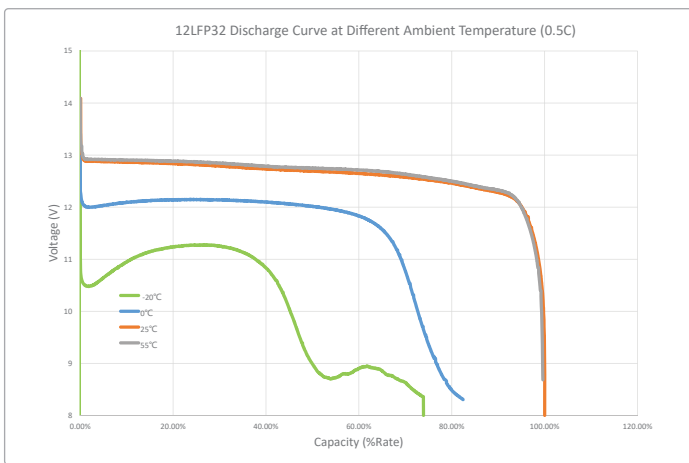
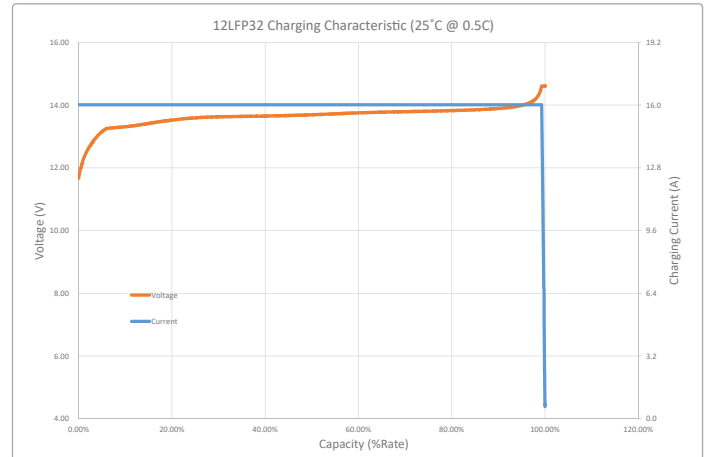
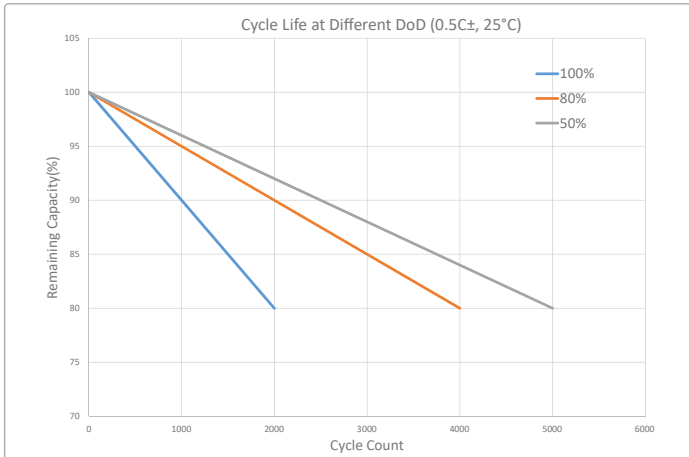

### FEATURES & BENEFITS



#### Long Service Life

>2000 cycles @100% DoD (25°C) to 80% of original capacity - longer service life than SLA to reduce maintenance costs.



#### High Energy Density - More Power p/kg

Higher total system capacity and superior utilisation (full 100% DoD) to reduce overall system size and footprint.



#### Robust Enclosure

Enclosed in IP5x (dust resistant) or IP6x (dust tight) case with closed loop terminals - suitable for harsh environments.



#### Stable Chemistry & Built-in Circuit Protection

IEC & UN38.3 Safety Certified at cell level and integrated BMS protection to ensure safety and prevent damage.



#### Lightweight

Approx. 1/2 the weight (or less) of equivalent in SLA means lower logistics costs and minimal OH&S concerns.



#### Superior Charge & Discharge Efficiency

Faster charge/discharge rates (C/2 LiFePO4 vs C/20 SLA) for higher power usage and less downtime when charging.



#### Wide Operating Temperature Tolerance

Suitable for use in a wider range of applications where ambient temperature is atypical: from -20°C up to +60°C.



#### Fully Recyclable Battery

An environmentally friendly battery option, with no lead or calcium that can leak into the environment.

### BUILT-IN PROTECTION

All Drypower Rechargeable Lithium batteries adhere to strict safety guidelines by incorporating Battery Management Systems (BMS) that include protection components such as:

- Integrated Circuit (IC)
- Thermistor
- MOSFET
- Protection Circuit Module (PCM)
- Fuse

The BMS in each Drypower battery helps to:

1. Maintain safety for users.
2. Prevent damage to equipment and property.
3. Eliminate concerns about use of the wrong type of charger.
4. Minimise the risk of overdischarge causing damage.
5. Provide short circuit and overcharge protection.

### CAUTIONS

- Do NOT short circuit, crush or disassemble.
- Do NOT heat or incinerate.
- Do NOT immerse in any liquid.
- Do NOT allow the battery to become overdischarged. If possible, isolate the battery when not in use.
- Do NOT leave the battery in a discharged state. Always recharge after use with a Drypower approved LiFePO4 charger.
- Store at 50% capacity. Recharge every 3 months. The storage area should be clean, cool, dry and ventilated.
- Stand alone use only. No parallel connection allowed.

Performance may vary depending on application. All specifications are correct at time of creation. All specifications and operation conditions contained in this datasheet are subject to change or improvement without prior notice to the user. This data is for evaluation purposes only. No guarantee is intended or implied by this data. For clarification and updated information, please contact us • Oct2020